

COMPLEMENT DE LA NOTICE POUR PORTE A PORTILLON

15

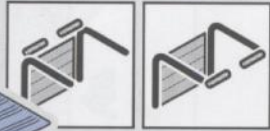

15.1

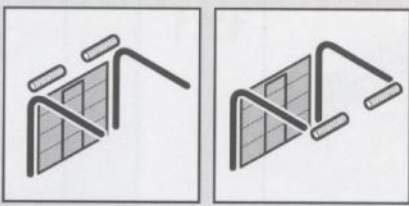

15.2



15.3



15.4



15.5

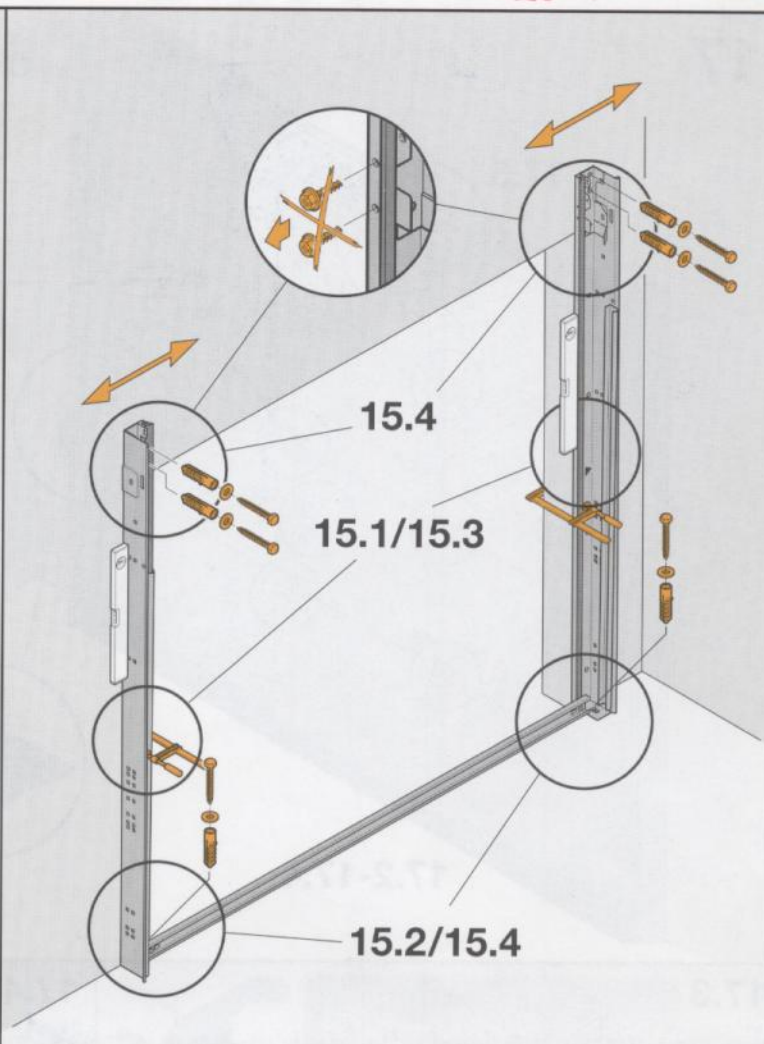

16

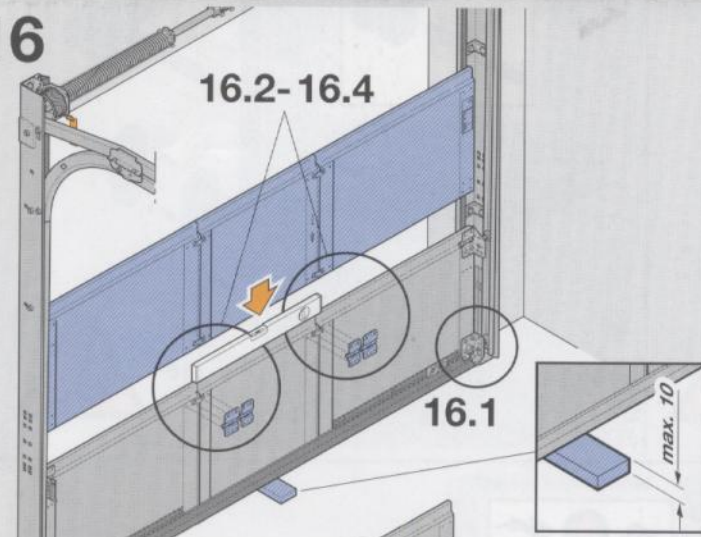

16.1

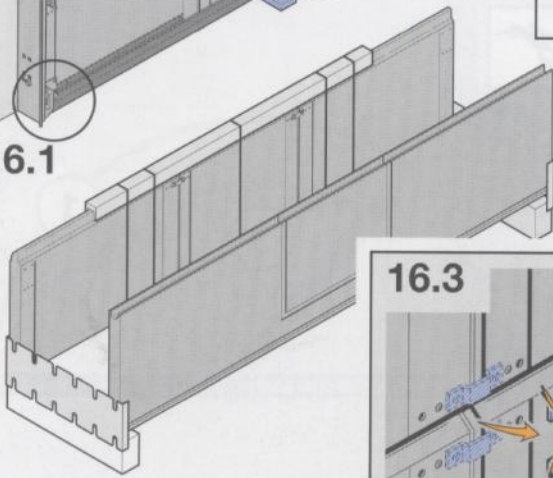

16.3

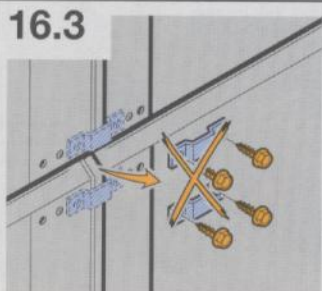

16.1

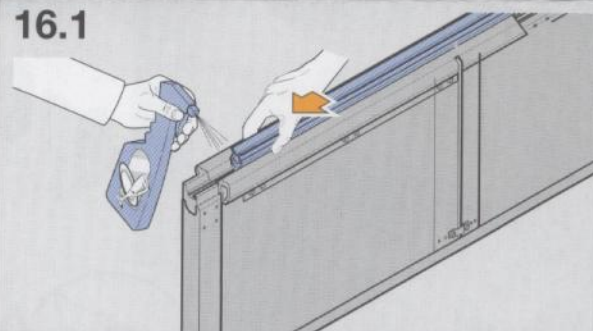

16.2



16.4

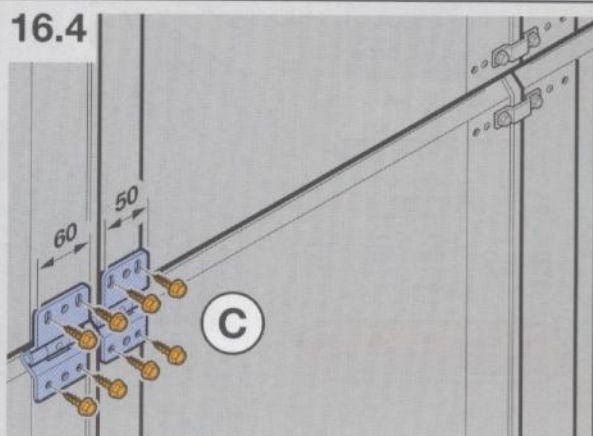

17

17.5

17.1

17.1

18

17.2-17.4

17.1

17.2

17.3

17.4

17.5

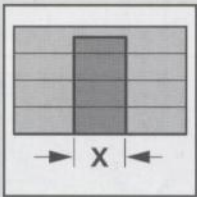

X →

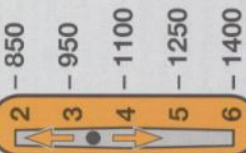

3

1

